

Honeywell

OPERATION MANUAL

Built-in x35 ZOOM / WDR
High Resolution AUTO FOCUS CAMERA

HZC-855NX/PX Series



READ AND KEEP THIS OPERATION MANUAL



CAUTION

RISK OF ELECTRIC SHOCK
DO NOT OPEN

CAUTION:
TO REDUCE THE RISK OF ELECTRIC SHOCK, DO NOT REMOVE COVER (OR BACK). NO USER SERVICEABLE PARTS INSIDE.
PREFER SERVICING TO QUALIFIED SERVICE PERSONNEL.



Indicate a potentially hazardous situation which if not avoided, may result in minor or moderate injury. It may also be used to alert against unsafe practices.

Warning:

This equipment generates and uses radio frequency energy and if not installed and used properly, i.e., in strict accordance with the instruction manual, may cause harmful interference to radio communications. It has been tested and found to comply with the limits for a Class A computing device pursuant to Subpart J of Part 15 of FCC Rules, which are designed to provide reasonable protection against such interference when operated in a commercial environment.

Warning:

TO PREVENT FIRE OR SHOCK HAZARD, DO NOT EXPOSE THIS APPLIANCE TO RAIN OR MOISTURE.



CAUTION FOR SAFE OPERATION

1. Water and Moisture

To prevent fire or shock hazard, do not expose this camera to rain or moisture.

2. Servicing

Do not attempt to disassemble or repair by yourself. You may be exposed to dangerous voltage or other hazards. Note that all servicing is qualified service personnel. Modifications not approved by manufacturer could void the user's authority to operate the equipment.

3. Power Sources

To prevent electric shocks and risk of hazards, do not use more than the specified power source.

4. Environment

Do not install too warm or too cold place. Recommended operation temperature is between -5°C and 60°C

5. Sunlight

Do not point the camera at the sun. CCD can be damaged.

6. Heavy Shock and Vibration

Do not drop the camera or subject it to heavy shock of vibration.

7. Install on an Unstable Place

Do not place or install this camera on an unstable place, stand, tripod, bracket or table. That may cause serious injury to people or damage to appliance.

8. When operation is incorrect or a malfunction is observed

While operating, if any abnormal condition (strange sound, smell or smoke) or a malfunction (no pictures, etc.) is observed, stop using the camera immediately, turn the power off, then contact your supplier.

9. Cleaning

Turn the power off and wipe off the dirt with a dry soft cloth. If it is extremely dirty, use furniture cleaner to wipe it off. To clean the lens, use a blower or lens cleaning tissue. (available from any camera dealer)

10. Do not shoot any source of bright light.

If the objects contain very bright areas, bright vertical or horizontal lines may appear on the screen. This is called "smear", a Phenomenon which often occurs with solid-state pickups, and is not a malfunction.

11. Damage Requiring service

Unplug the camera from the power source and refer servicing to qualified service personnel under the following condition:

- a. If the power-supply cord or plug is damaged.
- b. If the camera has been exposed to rain or water.
- c. If liquid has been spilled, or objects have fallen into the camera.
- d. If the camera does not operate normally by following the operating instructions. Adjust only those controls that are covered by the operating instructions as an improper adjustment of other controls may result in damage and will often require extensive work by a qualified technician to restore the camera to its normal operation.
- e. If the camera has been dropped or the cabinet has been damaged.
- f. If the camera exhibits a distinct change in performance.

Warranty is not covered in case of natural disaster or wrong Installation.

CONTENTS

| | |
|---|-----------|
| 1. <i>Features</i> | 5 |
| 2. <i>Terms & Functions</i> | 6 |
| 3. <i>Installation</i> | 7 |
| 4. <i>Camera Control Methods</i> | 8 |
| 5. <i>On Screen Display</i> | 10 |
| 6. <i>Specifications</i> | 21 |
| 7. <i>Dimensions</i> | 22 |

Thank you for using our Auto Focus Zoom Color Camera. To get the best efficiency, read carefully all instructions in this manual before use, and keep this manual for reference. If you have any problems with this camera, contact your supplier to service.

1. Features

Ideal Digital Video Camera for Security

The HZC-855NX/PX Ser. is a compact camera that offers easy system integration. Coming with the built-in zoom lens, the user can monitor the scene from variable angle without the extra lens.

With the DSP technology, such intelligent controls as auto iris, and auto white balance are possible to realize clear detailed picture. Additionally, through RS-232C, RS422, remote Focus/Zoom operations are also possible, along with manual control. All these features including highly sensitive 1/4-inch CCD make the ideal digital processing CCTV camera HZC-855NX/PX series more effective surveillance.

Built -in x35 Optical power zoom lens

The HZC-855NX/PX Ser. with highly durable built-in zoom lens offers auto focus, auto iris , and optical zoom functions enabling the user to monitor a scene with clarity in any desired angle of view.

With the x35 optical zoom lens, the total zoom can be up to x90 with x2.5 digital zoom processing.

High Resolution & Sensitivity SONY CCD

The chassis features a highly sensitive 1/4-inch CCD pickup with approximately 380,000 effective pixels minimizing residual image and geometric distortion. All images are reproduced with a high horizontal resolution of 530 TV lines for fine detail.

High Sensitivity with Integration and removal of IR filter

HZC-855NX/PX Ser. has the increased light sensitivity to 0.0005lx (510 fields, IR Cut Filter ON) through field (frame) integration technology. With Integration and removal of IR cut filter make more effective surveillance though low light condition.(HZC-855NX/PX : less than 0.00001 lx)

Privacy Zone Masking

HZC-855NX/PX Ser. mask the unwanted view for privacy protection up to 8 zones. Privacy Zone operate with zoom in/out and it increases the effect of privacy protection.

Remote Control through RS232C, RS422 Interface

Remote control operations are possible through RS232C/RS422 interface for Focus, Zoom control and various functions.

AI / Fuzzy Control Circuit with DSP

Advanced DSP technology automatically adjusts operations such as Iris , White Balance flexibly adapting to environmental conditions.

Auto Iris : the iris is adjusted so that visual output is kept at a fixed level, even if brightness of the surrounding changes.

Auto White Balance : color adjustment according to the color temperature of the light source illuminating the subject. white balance can be obtained even with fluorescent lights, halogen lamps or outdoor.

WDR (Wide Dynamic Range)

This is the technology using dual shutters from both dark and bright areas to be enhanced and displayed vivid video image. While a conventional image shows white clip caused by the bright spot, WDR overcomes and solves the obstacle of the white clip problem.

2. Terms & Functions

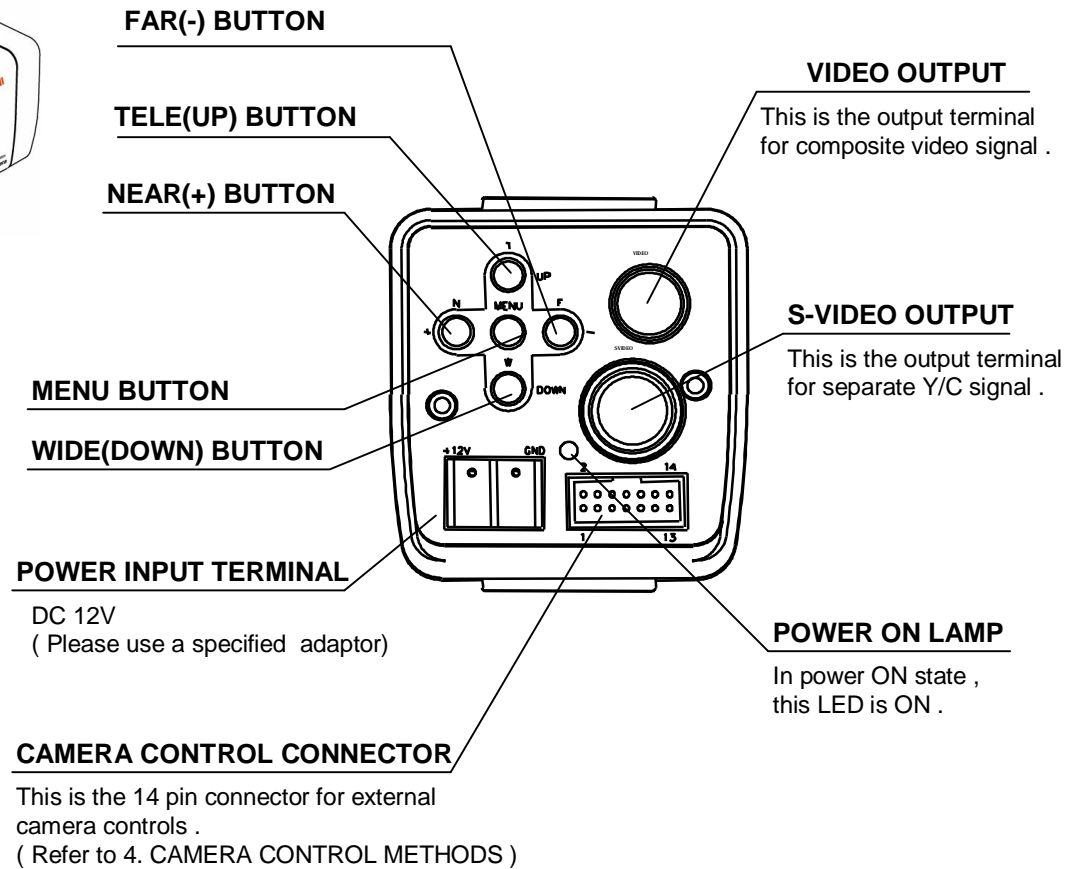
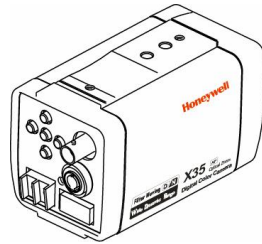

3. Installation

3.1 Check all accessories with enclosed package .

- HZC-855NX/PX Ser. SET
- 14 PIN CONNECTION CABLE (150mm)
- OPERATION MANUAL



HZC-855NX/PX Ser.

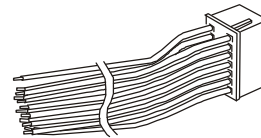

14 PIN CABLE*

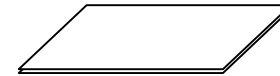

OPERATION MANUAL

* CABLE DESCRIPTION

- | | | | |
|------------|------------|------------|------------|
| 1. KEY1 | (RED) | 2. KEY2 | (YELLOW) |
| 3. ZOOM | (GREEN) | 4. FOCUS | (BLUE) |
| 5. MENU | (WHITE) | 6. COM | (ORANGE) |
| 7. GND | (BLACK) | 8. GND | (BLACK) |
| 9. R+/NC | (BROWN) | 10. R-/RD | (PINK) |
| 11. T+/TD | (VIOLET) | 12. T-/GND | (GRAY) |
| 13. EXT_VD | (WHITE) | 14. GND | (BLACK) |

4. Camera Control Methods

4.1 Remote Control using for Hard wired connection (Connector pin 3,4,5,6)

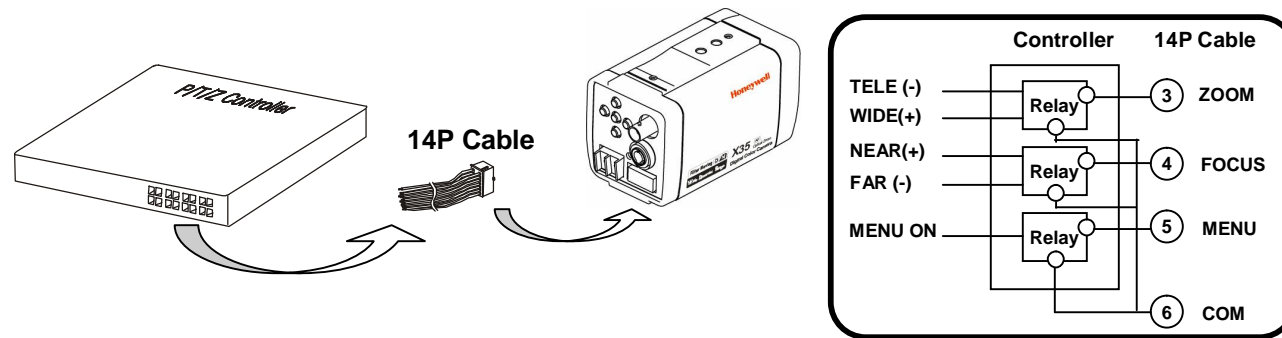

4.2 Remote Control using for RS-232C connection (Connector pin 10,11,12)

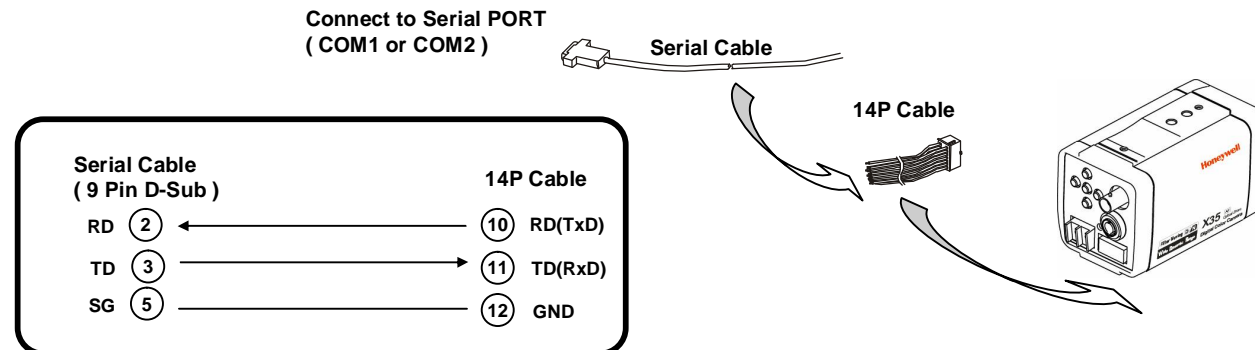

4.3. Remote Control using for RS-422/485 connection (Connector pin 9,10,11,12) ----- OPTION

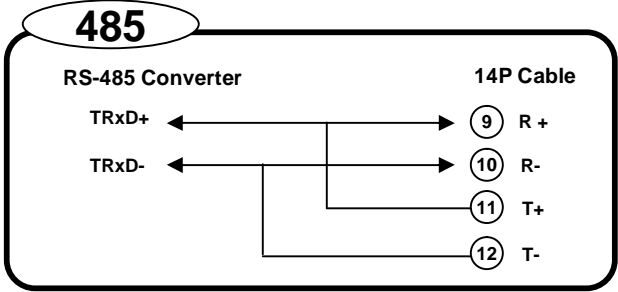
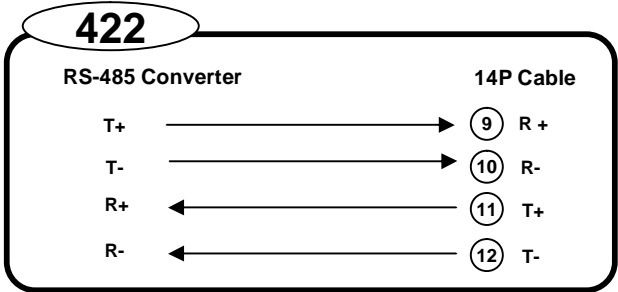
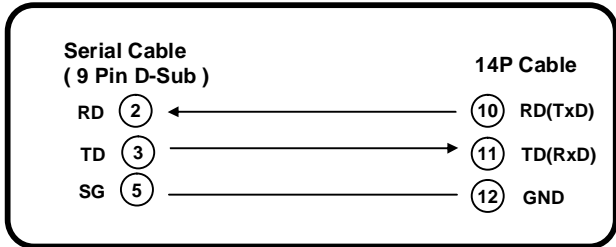
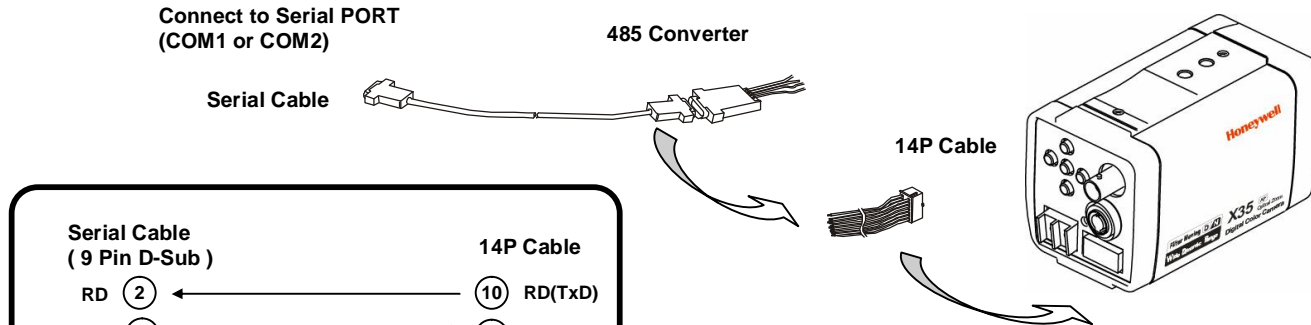

5. On Screen Display

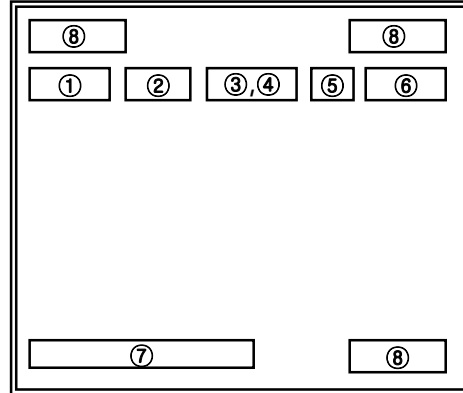

<Fig5-1. Operating OSD display position>

5.1 How to display Operating OSD

- a. Pressing the MENU key softly confirm current Operating OSD.
It is disappeared about five seconds later if there are no other key actions.
- b. When it zoom in or out pressing TELE(up) or WIDE(down) key, whole Operating OSD is displayed and then disappeared.
Press NEAR(+), FAR(-) key, only upper part of Operating OSD (for displaying camera mode) is displayed and then disappeared.
(It is for checking current whole camera mode and zoom position)
- c. Even though Operating OSD is disappeared, it keep displaying ID in lower part of screen.
In order to do not display ID, one method is to change EEPROM data of Camera, the other is to use external communication through RS-232C.
- d. Using RS-232C communication, change display position of ID;
Bottom Right -> Top Left -> Top Right -> Non display.

* If display Operating OSD is not needed by special purpose like using external text overlay board, it can be OFF mode at all times through external communication control as RS 232C.

| | FUNCTION | OSD Format | DESCRIPTION |
|---|-----------------|---|------------------------------------|
| ① | Focus Mode | Non display | Auto Mode |
| | | MF | Manual / Oneshot Mode |
| ② | Back Light | Non display | Backlight OFF |
| | | BL | Backlight ON |
| ③ | Flickerless | Non display | Flickerless OFF |
| | | FL | Flickerless ON |
| ④ | Shutter Speed | Non display | NTSC: 1/60 |
| | | 1 / 125 1 / 5 0, 0 0 0 | 9 variable steps |
| ⑤ | Night Mode | Non display | Nightshot OFF |
| | | IR | Nightshot ON |
| ⑥ | WB MODE | Non display | Auto Tracking WB mode |
| | | IN | Indoor Preset (3200°K) |
| | | OUT | Outdoor Preset (5400°K) |
| | | MWB | Manual WB mode |
| | | AWC | One Push mode |
| ⑦ | ZOOM DISPLAY | AWB | Auto WB mode |
| | | x35 | Optical Zoom |
| | | Dx90 | Digital Zoom |
| | | >> TELE | zoom IN |
| ⑧ | CAMERA ID/TITLE | << WIDE | zoom OUT |
| | | Non display | In case that ID is 0 |
| | | ID : 002 | In case that ID is 1 ~ 255 |
| | | TITLE | DISPLAY set as TITLE |

<Table5-1. Operating OSD description>

5.2 OSD SETUP MENU Structure

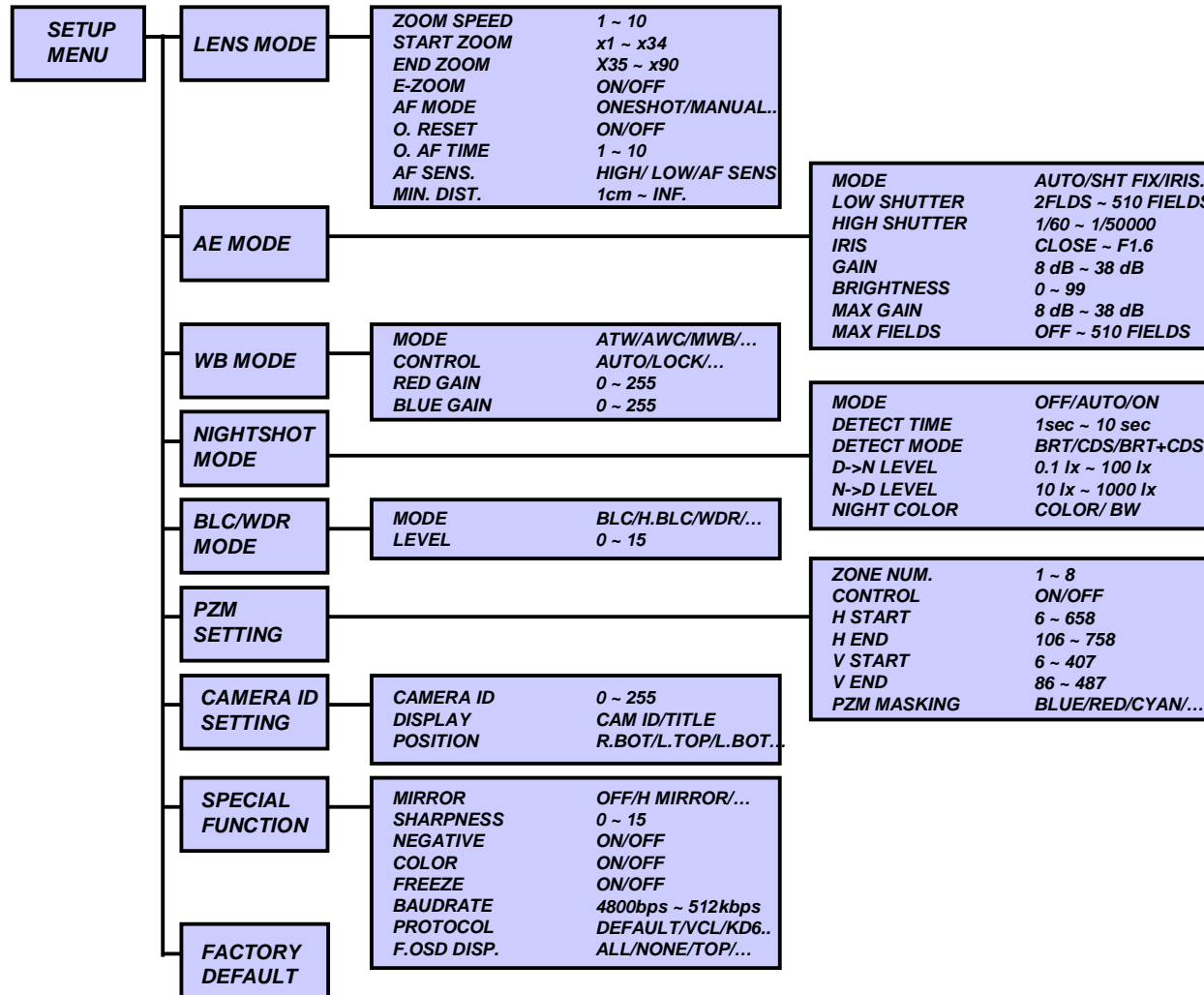

5.2 Display SETUP MENU

- Press MENU key above 2 seconds so that SETUP MENU 1 is displayed on the screen.
- Select item of SETUP MENU using TELE(up) / WIDE(down) key.
- NEAR(+) / FAR(-) key is used to increase / decrease data of selected item.

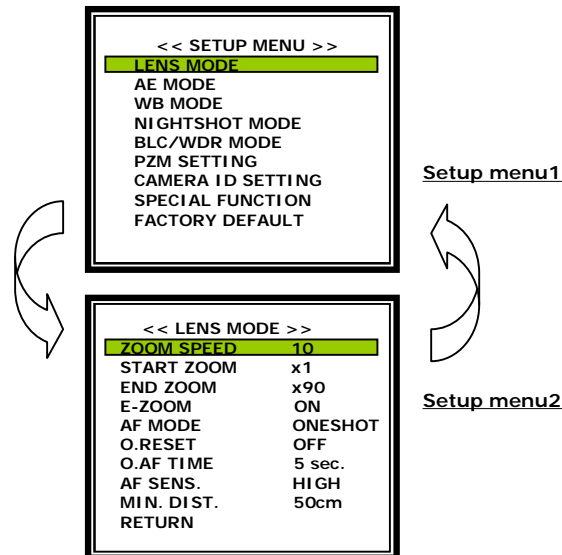

<Fig5-2. SETUP MENU change>

5.3 Move between SETUP MENU 1 and SETUP MENU 2

- In order to change from SETUP MENU1 to SETUP MENU 2, select NEXT MENU using TELE / WIDE key, and press NEAR / FAR key.
- In order to change from SETUP MENU 2 to SETUP MENU1, select RETURN MENU using TELE / WIDE key, and press NEAR / FAR key.

5.4 Quit SETUP MENU

- Press the MENU key again. SETUP MENU is disappeared, "SAVE?" or "QUIT?" is displayed at center of screen. If there is no change of adjustment state of Camera, "QUIT?" is showed, else "SAVE?" is showed.
 - ① "QUIT?" : quit SETUP MENU without saving changed value.
 - ② "SAVE?" : quit SETUP MENU with saving changed value.
- Press NEAR / FAR key to choose, and press the MENU key again. whole SETUP MENU is quitted.
(If MENU key is not pressed and TELE / WIDE key is pressed, SETUP MENU is appeared again.)

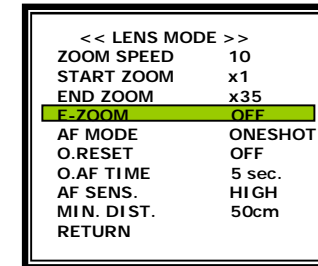

5.5 LENS MODE

- ① ZOOM Speed Control
: Set zoom speed 1 to 10, 10 steps.
ZOOM SPEED 1 → 2 → ... → 10
- ② Start Zoom Ratio
: Set boundary value of WIDE zooming.
START ZOOM x 1 ~ x 34 (in optical zoom region)
- ③ End Zoom ratio
: Set boundary value of TELE zooming. It can be set up to x90 including electronic zoom. (in case the digital zoom limit is 2.5 times) Since Start Zoom and End Zoom ratio are set, simultaneously Camera moves to setting zoom times. So it can be enable to adjust in moving to desired position.
END ZOOM x 35 ~ x 90 (in digital zoom region)

④ E-Zoom Control

: ON means up to x230, OFF means only optical zoom region.

E-ZOOM OFF → ON →

⑤ Set Focus Mode

: It is composed of three modes.

AUTO

:Use to focus automatically all the time.

MANUAL

: Use to focus manually by pushing NEAR(+) / FAR(-)key.
Even though MANUAL mode, it will be focused in about 5 seconds after zoom in(TELE) / out(WIDE), and return to MANUAL mode automatically.

This is for focusing accurately after zooming.

ONESHOT

: It is similar to MANUAL mode. But there are some difference.
In case the focus mode is ONESHOT, it is focused whenever ONESHOT (AUTO/MANUAL key) key is pushed. It will be returned to MANUAL mode after seconds (Special Menu : O.S. AF TIME) even though can not be found best focus. In this case push ONESHOT(AUTO/MANUAL key) again, it will be in best focus.

PUSHAUTO (option)

: While pushing key, Focus mode will be AUTO.

⚠ caution

1. According to Model , order is Auto -> Manual -> Oneshot, or Auto > Manual -> Pushauto.

| | |
|-----------------|---------------|
| << LENS MODE >> | |
| ZOOM SPEED | 10 |
| START ZOOM | x1 |
| END ZOOM | x90 |
| E-ZOOM | ON |
| AF MODE | MANUAL |
| O.RESET | OFF |
| O.AF TIME | 5 sec. |
| AF SENS. | HIGH |
| MIN. DIST. | 50cm |
| RETURN | |

<Fig5-3. LENS MODE >

⑥ ONESHOT AF RESET

: Use in case of focus deviation due to impact, vibration etc.
Auto Focusing is operated during set time.

O.RESET OFF → ON →

⚠ caution

1. It happens focus deviation according to circumstance condition (brightness, facility to focus the object, etc).

⑦ ONESHOT AF TIME

: Set Oneshot AF operating time. When AF is completed, Focus mode will be Manual. Though AF is not completed, it stops when time is up.(unit:sec)

O.AF TIME 1 → 2 → ... → 10

⑧ AF Sensitivity

: **HIGH** : Reaction of Auto Focus is fast. It can be used when it shoot objects moving fast.

LOW : Auto Focus is more stable. In fast moving scene, AF doesn't work even though the scene is changed. It is for stabilizing the scene.

AF SENS. HIGH → LOW →

⑨ Minimum Distance

: Set the minimum distance which can be focalized.

MIN. DIST. 1cm → 10cm → 50cm → 1m → 3m → 10m → INF.

| | |
|-------------------|-------------|
| << LENS MODE >> | |
| ZOOM SPEED | 10 |
| START ZOOM | x1 |
| END ZOOM | x90 |
| E-ZOOM | ON |
| AF MODE | MANUAL |
| O.RESET | OFF |
| O.AF TIME | 5 sec. |
| AF SENS. | HIGH |
| MIN. DIST. | 10cm |
| RETURN | |

<Fig5-4. Minimum Focus Distance MODE>

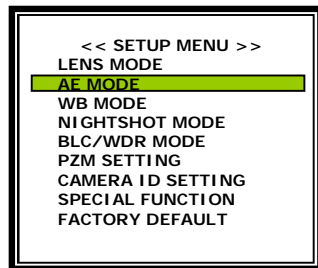

<Fig5-5. AE MODE >

5.6 AE MODE

- ① Exposure Mode
: It is composed of five modes according to circumstantial illuminance.

AUTO

: Exposure is controlled by Shutter Speed, Iris, Gain to meet the Brightness.

SHUTTER FIX

: Low/High shutter speed is fixed, Exposure is controlled by Iris and Gain.

IRIS FIX

: Iris is fixed, Exposure is controlled by Shutter Speed and Gain.
(Shutter Speed, GAIN is not adjust and operate automatically.)

GAIN FIX

: Gain is fixed, Exposure is controlled by Shutter Speed and iris.

MANUAL

: Shutter Speed, Iris, Gain is fixed as set value regardless of illuminance.

☞ caution

1. There are menu items not to adjust and to skip according to mode.
2. Field Integration is not operated in Shutter Fix, Gain Fix, Manual.

MODE **AUTO → SHT FIX → IRIS FIX →
GAIN FIX → MANUAL**

- ② LOW SHUTTER Speed
: In Shutter Fix, Manual Mode, range is from 1/30 sec (2 fields) to 2 sec (128 fields).
LOW SHUTTER **OFF → 2 FLDS ~ 128FLDS**
(FLDS means how many times integrated of CCD signal.)

- ③ HIGH SHUTTER Speed
: In Shutter Fix, Manual Mode, range is from 1/60 sec to 1/10,000 sec.
HIGH SHUTTER **1/60 → 1/100 → → 1/10000**

- ④ IRIS
: In Iris Fix, Manual Mode, range is 17 phases from F1.6 (full Open) to CLOSE.
IRIS **CLOSE → F22 → F19 → → F1.6**

- ⑤ GAIN
: In Gain Fix, Manual Mode, range is 17 phases from 8 to 38dB.
GAIN **OFF → 8dB → 10dB → → 38dB**

- ⑥ Brightness
: Adjust level of Auto Iris. The smaller brightness value is, the darker it is, because iris is closed more. On the contrary the bigger brightness value is, the brighter it is, because iris is opened more.
BRIGHTNESS **0 ~ 99**

- ⑦ MAX AGC
: Adjust Max AGC level.
MAX GAIN **OFF → 8dB → 10dB → → 38dB**

☞ caution

Max Gain is less than 14dB, and Field Integration does not work.

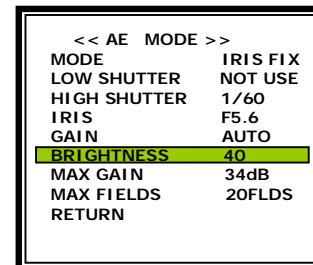

<Fig5-6. Brightness in AE Mode >

⑧ MAX FIELDS (option)

: Use for compensating the low illumination condition. In case that use this function because of low illumination condition, adjust maximum integration fields to get brighter and dynamical image. But the scene becomes slower than OFF mode. The larger max fields is, simultaneously the noise of image is larger. This is phenomenon because too small video output is integrated on many fields memory. To get more dynamical image, adjust maximum integration fields and set maximum AGC gain as HIGH, then make better the standard of dynamic image.

MAX FLDS **OFF** → 2FLDS → 3FLDS → 4FLDS → 5FLDS
 → 6FLDS → 7FLDS → 8FLDS → →
 → 80FLDS → 160FLDS → 320FLDS
 → 510FLDS

caution

1. In Fields Integration mode, noises as well as video information are increased. When an ambient temperature keeps high, CCD pixel defect happens to be larger and white. This is not due to failure.

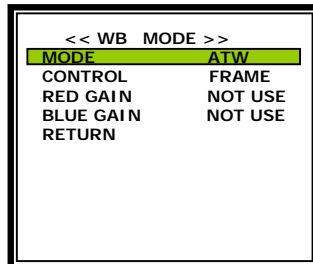
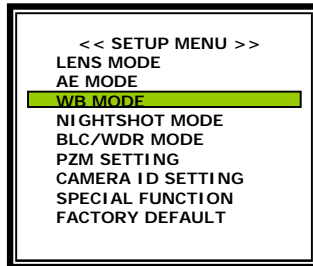

<Fig5-7. WB MODE >

5.7 White Balance Mode

① White Balance Mode

: Outer illumination condition is expressed by Color temperature, Kelvin (°K). It is White Balance that shows white as white in any illumination conditions. It is composed of five modes..

ATW (Auto Trace White balance)

: Trace automatically under any condition in range 2,800°K ~ 8,000°K (It can be adjustable red and blue point of desired white position.)

AWB

: Consider current illumination condition, do white balance by force and lock as manual

INDOOR

: Use to set the preset illumination condition as 3200°K

OUTDOOR

: Use to set the preset illumination condition as 5400°K

MANUAL

: Use to adjust to desired RED, BLUE gain manually.

AWC

: Consider current illumination condition, do white balance by force and lock as manual

② White Balance Mode Control

: It displays and changes White Balance Mode Control status of Camera. (According to Mode, it just display the state and not to adjust.)

| | |
|----------------|------------------------------|
| ATW | AUTO |
| INDOOR | 3200°K |
| OUTDOOR | 5400°K |
| MANUAL | R/B CONT |
| AWC | LOCK → PUSH → |
| AWB | AUTO |

(LOCK means Manual white balance status. Press NEAR(+)/ FAR(-) key continuously, LOCK mode becomes PUSH mode and white balance acts automatically, and then white balance mode is locked as manual.)

- ③ RED GAIN (Range is different on each Mode.)
: Adjust RED Gain, and tune the sensitivity of white point.
MANUAL **0 → 1 → → 254 → 255**
- ④ BLUE GAIN (Range is different on each Mode.)
: Adjust BLUE Gain, and tune the sensitivity of white point.
MANUAL **0 → 1 → → 254 → 255**

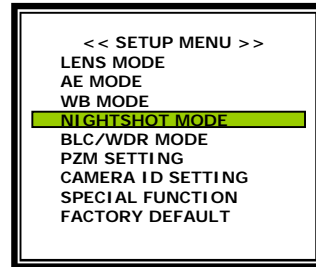

5.8 NIGHTSHOT MODE

- ① NIGHTSHOT MODE
: It is used in low illumination condition. ON is Night mode, OFF is normal state. Sensitivity of camera becomes more higher level like BW camera.
It can be available external IR illuminator. In case of AUTO mode is converted ON / OFF automatically according to illuminance change.
MODE **OFF → AUTO → ON →**
- ② NIGHTSHOT MODE DETECT TIME
: Set time to protect susceptible conversion of ON/OFF according to illuminance change on Auto. When illuminance keeps the state during detect time, convert ON/OFF.
DETECT TIME **1 sec. → 2 sec. → → 10 sec.**
- ③ NIGHTSHOT DETECT MODE
: It is good to use with external IR illuminator on Auto. Select CDS sensor ON/OFF to detect the illuminance state more effectively.
DETECT MODE **BRT → CDS → BRT+CDS →**

⚠ caution
BRT means shooting scene brightness, CDS sensor's operation depends on circumstantial brightness. Select to match with installation circumstance.

- ④ Turnover LEVEL from DAY TO NIGHT
: Set the LEVEL to turnover from Day to Night.
D→N LEVEL **0.1 lx → 1 lx → 10 lx →**
- ⑤ Turnover LEVEL from NIGHT TO DAY
: Set the LEVEL to turnover from Night to Day.
N→D LEVEL **10 lx → 100 lx → 1000 lx →**
- ⑥ Color on Nightshot Mode
: Set Color Mode on Night Mode.
NIGHT COLOR **B/W → COLOR →**

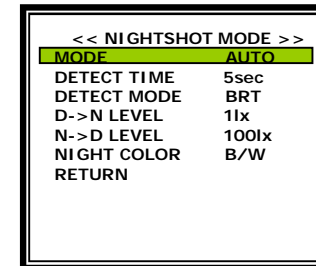

<Fig5-8. NIGHTSHOT MODE >

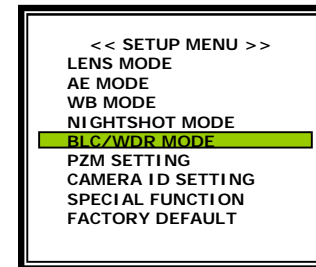

<Fig5-9. BLC/BMB Mode >

5.9 BLC/ WDR Mode

- ① Backlight Compensation Mode
: It is for preventing the center object too darken when the excessive light is behind the center object. Set BACKLIGHT ON, then brighten the center object in the contrast to the background light. Press NEAR/ FAR key in 2 sec, Backlight mode become AUTO.

MODE OFF → BLC → H.BLC → WDR → ...

**H.BLC [Histogram BLC] is enhanced BLC function.
H. BLC makes the center object brighter to clear image
where the behind scene is too brighter than the center object.**

- ② Backlight Compensation Level
BLC LEVEL 7 (0 ~ 15)
- ③ Histogram BLC Level (H.BLC LEVEL)
H.BLC LEVEL 10 (0 ~ 15)

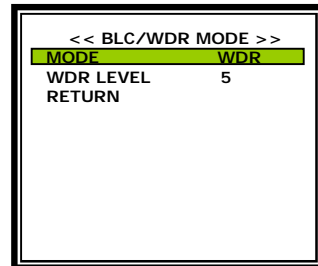

WDR [Wide Dynamic Range]

WDR is mostly useful function to take image from indoor to window. WDR is the new technology to reduce the differentiations between dark and bright areas.

- ④ WDR Level
WDR LEVEL 5 (0 ~ 15)

⚠ Cautions

1. While using WDR mode toward fluorescent lamp or bright light, you may find out unwanted color. However, this is normal condition for WDR function.
2. While using WDR mode, the digital zoom does not work.

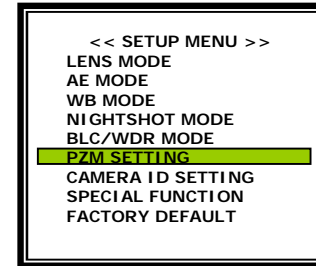

<Fig 5-10. Privacy Zone Setting >

5.10 PRIVACY ZONE

- ① Set Privacy ZONE
:PZM(Privacy Zone Mask) is to hide the unwanted view to protect privacy invasion. It works with Zoom/PAN/TILT operation. Select PZM zone upto 8 zones.
ZONE NUM. ZONE 1 → ZONE 2 → ... → ZONE 8
- ② PZM control
: Set ON/OFF for each PZM Zone.
CONTROL OFF → ON → ...
- ③ PZM Horizontal center starting point
: Set PZM for the starting point of Horizontal center.
H START 332
- ④ PZM Horizontal center ending point
: Set PZM for the ending point of Horizontal center.
H END 432
- ⑤ PZM Vertical center starting point
: Set PZM for the starting point of vertical center.
V START 206
- ⑥ PZM Vertical center ending point
: Set PZM for the ending point of vertical center.
V END 286
- ⑦ PZM Masking
: Choose the Color to mask the PZM zone. 8 color (Black,Gray, Light Gray,White,Red,Blue,Green,Yellow) is available.
PZM MASKING BLUE →RED → ... → GREEN

Quick setting method for Privacy Zone Masking

1. Zoom in wide as possible as you can.
2. Select Zone Number in "ZONE NUM."
3. Select "On" by push the right button.
4. Push Menu button on the "CONTROL" to be able to move to wanted position spot and push again to go back to main Menu.
5. Set the H and V value on the Menu.
6. Select a color.
7. Push Menu button to save the setting.

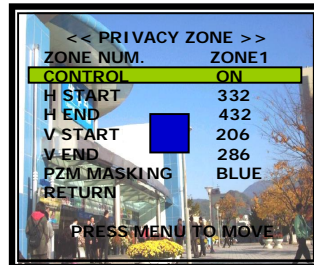

<Fig 5-11. Privacy Zone Setting >

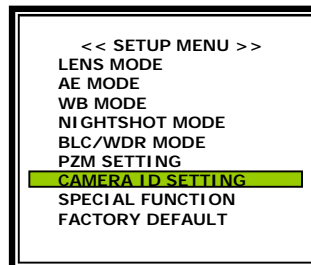

5.11 Camera ID SET

① ID SET

: Camera ID is indicating number assigned each Camera in case of controlling many Cameras. It is from 0 to 255. But in case of 0, that is not displayed on screen. It is always displayed even though whole Operating OSD is disappeared on the screen. But it is possible to make non display and to choose display position (BOTTOM RIGHT, TOP RIGHT, TOP LEFT) by RS-232C communication.

CAMERA ID **0 ~ 255**

☞ caution

1. In case of Camera ID FIX model, it cannot be selected..
2. ID is not changed by MENU control through communication.

② DISPLAY MODE

: Choose which is to display Camera ID or Title.

DISPLAY **CAM ID → TITLE →**

③ DISPLAY POSITION

: Choose where is to display Camera ID or Title on Right Bottom, Left Top, Right Top or not to display.

POSITION **R.BOT → L.TOP → R.TOP → NONE**

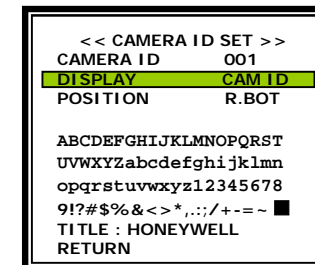

<Fig 5-12. CAMERA ID Setting>

- ④ Title
: It is the name of Camera. It enters 10 characters including blank..

TITLE: ■ ■ ■ ■ ■ ■ ■ ■ ■ ■

■ How to Enter the Title ■

Let's enter the Title as "R1", example

- Select the position of title character by using Near or Far key. The chosen position is blinking.
(Only chosen Cursor will be blink as "■", rest of them will be shown as a blank " ").

TITLE: □

- Select the character "R" among Ⓐ ~ Ⓓ by using UP,DOWN, (+),(-) key. The chosen character "R" is blinking.

ABCDEFGHIJKLMNOPQRST
 UVWXYZabcdefghijklmnop
 opqrstuvwxyz12345678
 9!?\$%&<>*,.:/+~=-■

- Press MENU key, the character "R" is entered in the Title. (Automatically the position will be forward to next position.)

TITLE: R □

- If you want to edit specified character, you shall use TELE/Wide to move on the position and NEAR/FAR to select on the character. By using TELE/WIDE to position the character to continue to edit.
- Select character "1" using TELE, WIDE, NEAR, FAR button and it will blink the cursor on the character "1"

ABCDEFGHIJKLMNOPQRST
 UVWXYZabcdefghijklmnop
 opqrstuvwxyz12345678
 9!?\$%&<>*,.:/+~=-■

- Push MENU to enter the character "1".

TITLE: R 1 □

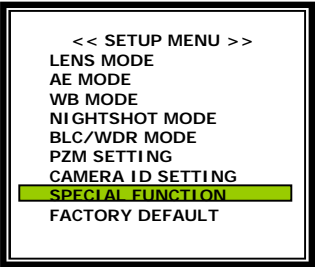

5.12 SPECIAL FUNCTION

- ① Mirror Mode
: Mode ON is Mirror Mode, OFF is general screen state.
MIRROR OFF → H MIRROR →
 V MIRROR → FLIP
- ② Sharpness
: Use to change the contour of Scene.
SHARPNESS 0 ~ 15
- ③ Negative Mode
: Use for Positive and Negative mode. ON is Negative mode, OFF is Positive mode namely general screen state.
NEGATIVE OFF → ON → ...
- ④ Color Mode
: Use for changing color and monochrome (black & white)mode .
ON is Color mode, OFF is black&white mode.
COLOR ON → OFF → ...

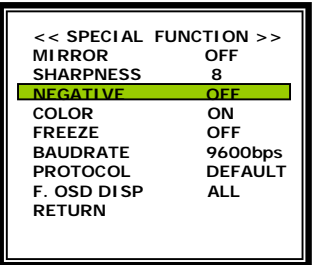

<Fig 5-13. SPECIAL FUNCTION>

⑤ Freeze Mode

: It pause current image. ON is to stop, OFF is to return to normal state.

FREEZE ON → OFF → ...

 **caution**

1. Freeze image does not save when you reset the system. This system doesn't have its' own memory.

⑥ BAUD RATE

: Use to communicate through RS232C, RS485, RS232TTL .

**BAUDRATE 4800bps → 9600bps → ...
 → 312kbps**

 **caution**

1. If the Baud Rate does not match between Camera and external system, it may occur the communication failure. Please make sure a proper Baud Rate.

⑦ PROTOCOL Setting

: Setting the PROTOCOL with communication device.

PROTOCOL DEFAULT → VCL → KD6 → P/D → ...

⑧ Function OSD Display

**OSD DISP ALL → NONE → TOP →
 BOTTOM →**

ALL : Whole Function OSD display
 (Focus Mode, Key state, Zoom Ratio, ID)

TOP : Only Upper OSD display (Focus Mode, key
 state)

BOTTOM : Only Lower OSD display (Zoom Ratio, ID)

NONE : All the OSD will not display except MENU
 OSD.

 **Caution**

1. The display of ID and TITLE can be only set in CAMERA ID SETTING.

5.13 Initial Set

: Set the INITIAL SET Mode ON so that all changed data are returned to shipping condition. For Initialization, select "YES?" by using NEAR, FAR key and push MENU key. Select "NO?" and push MENU, no initialization and return to Main Menu.

 **caution**

1. Make sure when Initialization set as "YES?" , all changed data are return to shipping condition.
2. Some menu as ID,TITLE, etc are not initialized.

6. Specification

| Model Name | HZC-855NX | HZC-855NX-VR | HZC-855PX | HZC-855PX-VR |
|-------------------------|--|-----------------|--|-----------------|
| Pick up Device | 1/4" Sony Double Scan CCD (Ex- View CCD) | | | |
| Total/Effective Pixels | 410,000 / 380,000 | | 470,000/440,000 | |
| Scanning System | 2:1 Interlace | | | |
| Lens | Optical x35, f = 3.6~126mm, F1.65(WIDE) ~ F4.2(TELE) | | | |
| Digital Zoom Ratio | x36 ~ x90 can be adjustable | | | |
| Sync. System | Internal line lock/ VD pulse lock(AutoDetect) | | | |
| H. Resolution | More than 530 TV Lines | | | |
| S/N Ratio | More than 50 dB (AGC OFF) | | More than 49 dB (AGC OFF) | |
| Min. illuminance | 0.5 lx (30IRE) ; 0.05 lx (IR FILTER OFF) ; 0.0005 lx (510 fields) ; 0.00001 lx (510 fields, IR FILTER OFF) | | 0.6 lx (30IRE) ; 0.06 lx (IR FILTER OFF) ; 0.0006 lx (510 fields) ; 0.00001 lx (510 fields, IR FILTER OFF) | |
| Focus Mode | Auto / Manual / Oneshot | | | |
| Brightness | 0 ~ 99 adjustable | | | |
| Shutter Speed | 1/60(50) ~ 1/50,000 | | | |
| Field Integration | x2 ~ x510 adjustable | | | |
| Mirror | Horizontal Mirror / Vertical Mirror / FLIP(Horizontal Mirror + Vertical Mirror) | | | |
| Day & Night Mode | AUTO / ON / OFF (CDS Sensor ON/OFF) | | | |
| Privacy Zone | ON (Max 8 area) / OFF | | | |
| AGC | ON (8 ~ 38dB) / OFF | | | |
| White Balance | AUTO(ATW, AWC) / OneShot / Indoor / Outdoor / Manual /AWB | | | |
| BLC (BMB) | BLC : ON / OFF / H.BLC ,/ WDR | | | |
| Remote Control | RS-232C | RS-422 / RS-485 | RS-232C | RS-422 / RS-485 |
| Power Supply/Consump. | DC 9V ~ DC 14V (Motor Activate 6 W , Motor Stop 4.0 W) | | | |
| Operation/Storage Temp. | -10 ~ 60 °C (Recommended -5 ~ 50 °C) / -20 ~ 60 °C | | | |
| Dimension / Weight | 62 x 71.6 x 116 (mm) / 510g | | | |

7. Dimensions

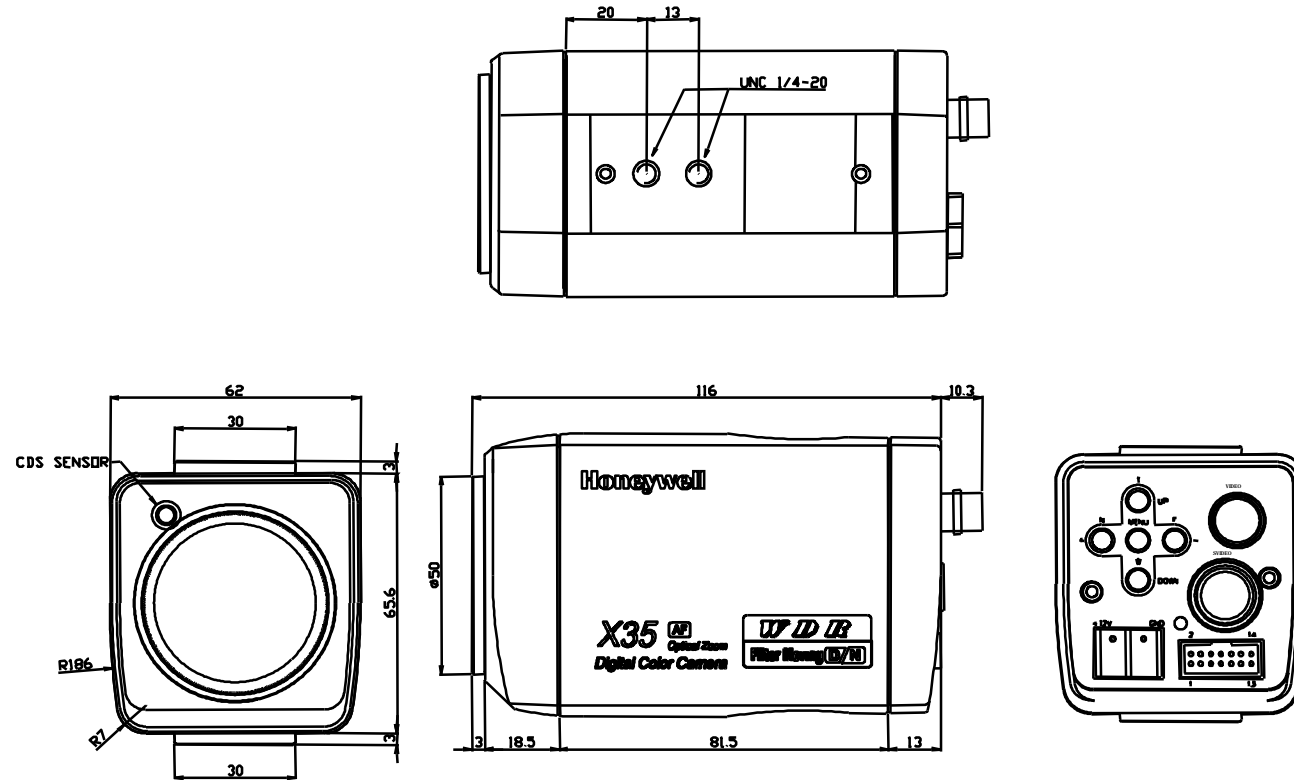

MEMO

Honeywell

Honeywell Co., Ltd.

Address : 17F, Kukje Center Building 191, Hankangro -2ga,

Yongsan-gu, Seoul 140-702, Korea

Phone : 82-2-799-6109, 6108, 6107, 6292

Fax : 82-2-749-6119

[http : //www.honeywell.co.kr/security/english](http://www.honeywell.co.kr/security/english)

E-mail : info.security@honeywell.com

Printed in Korea

G-113864-001